



 **GRÜNIG+ELMIGER**
SWITZERLAND



 **SIGSAUER**

ORDONNANZ



Erklärung Katalogaufbau

Vielen Dank für Ihr Interesse an unseren Produkten.

Dieser Katalog ist mit einem Register aufgebaut.

Die Registerzahlen finden Sie auf der Seite oben rechts in einem grauen Kreis.

Auf den Seiten 5-12 sehen Sie die verschiedenen Varianten der neuen Stgw 90 Visierteile und welches Zubehör in welchem Register zu finden ist.

Weitere Varianten finden Sie in den verwiesenen Registern.



Inhaltsverzeichnis

Linie Basis	2-3		Öle, Fette & Reiniger Stgw 90/Stgw 57 . . .	37	Register 9
Linie Standard Trommel	4-5		Reinigung Stgw 90		
Linie Standard Diopter	6-7		Putzstöcke Stgw 90	38	Register 10
Linie Premium.	8-9		Bürsten Stgw 90	39	Register 10
Kolben, Handschutz & Griff Set	10-11	Register 1	Kolben & Adapter Stgw 90	40	Register 10
Kolben	12	Register 1	Filze, Schnüre & Sets Stgw 90.	41	Register 10
Schaftbacken/Wangenauflagen.	13	Register 1	Reinigung Stgw 57		
Irisblenden zu Visierträger	15	Register 2	Putzstock Stgw 57	42	Register 11
Diopter und Zubehör.	16-17	Register 3	Adapter Stgw 57	43	Register 11
Hülsenfänger	18		Bürsten Stgw 57	43	Register 11
Irisblenden zu Diopter.	20-24	Register 4	Patches, Filze & Weiteres Stgw 57	44	Register 11
Korn	26	Register 5	Läufe und Zubehör Stgw 57	45	Register 12
• kompatibel Linie Basis			Koffer und Futterale Stgw 57	46	Register 13
• kompatibel Linie Standard Diopter			Koffer und Futterale Stgw 90	47-48	Register 14
• kompatibel Linie Standard Trommel					
Korn Zubehör	27	Register 5			
• kompatibel Linie Basis					
• kompatibel Linie Standard Trommel					
• kompatibel Linie Standard Diopter					
Korn und Korn Zubehör	28-29	Register 6			
• kompatibel Linie Premium					
Korn Visierung	30-32	Register 7			
Diverses Zubehör	33-36	Register 8			

Linie Basis

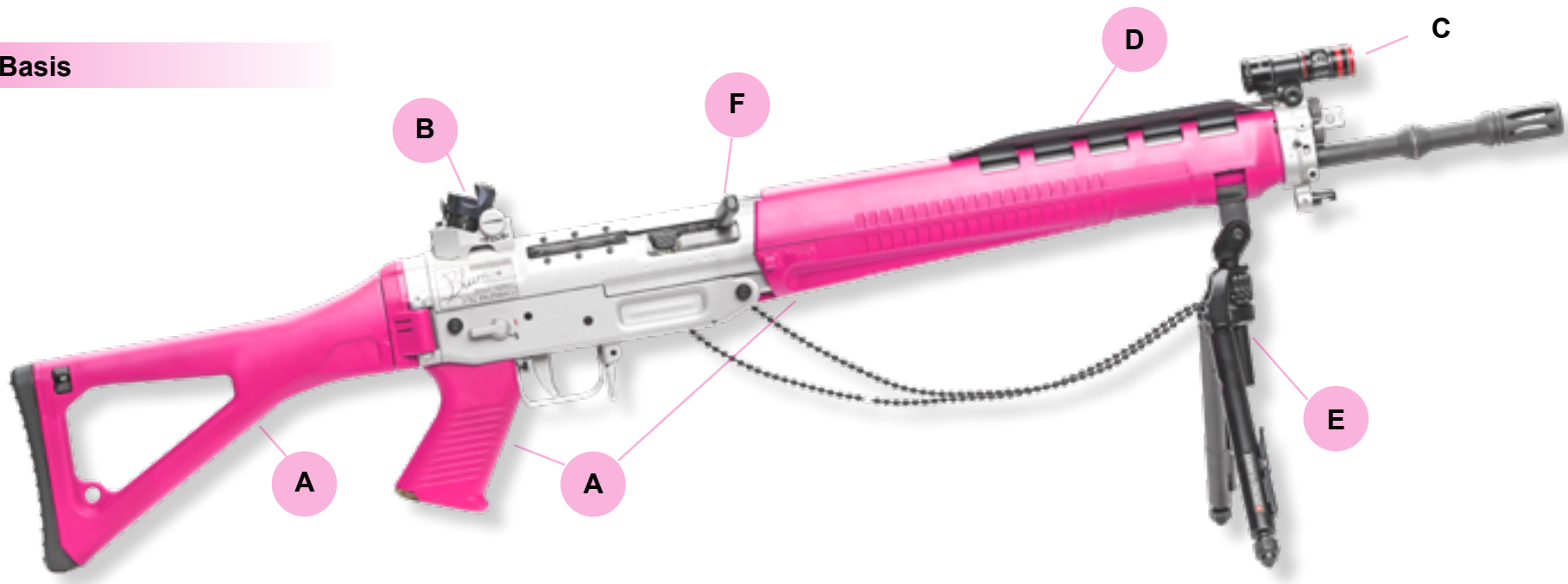

Linie Basis **mit** Irisringkorn Stgw 90, **exkl.** Irisblende, Farbfilter und Zweibeinstütze **ab CHF 785.—**

A Kolben, Handschutz, Griff

SIG Sauer Stgw 90 Kolben, Handschutz, Griff Set

Art. Nr. 70.34.019477

Register 1

B Visierung Trommel

G+E Stgw 90 Irisblende, mit Filterkassette (2023)
komplett mit 12 Farbfiltern

Art. Nr. 16.2140

Register 2

C Korn

G+E Stgw 90 Iris-Ringkorn einzeln

Art. Nr. 14.9720

Register 5

D Hitzeabweiser

G+E Stgw 90 Flimmerabweiser

Art. Nr. 14.9715

Register 8

E Zweibeinstütze

G+E Zweibeinstütze ERGONOMIC für Stgw 90

Art. Nr. 14.9750

Register 8

F Ladehebel

Stgw 90 Ladegriffüberzug schwarz

Art. Nr. 16.2183

Register 8



Linie **Standard Trommel**

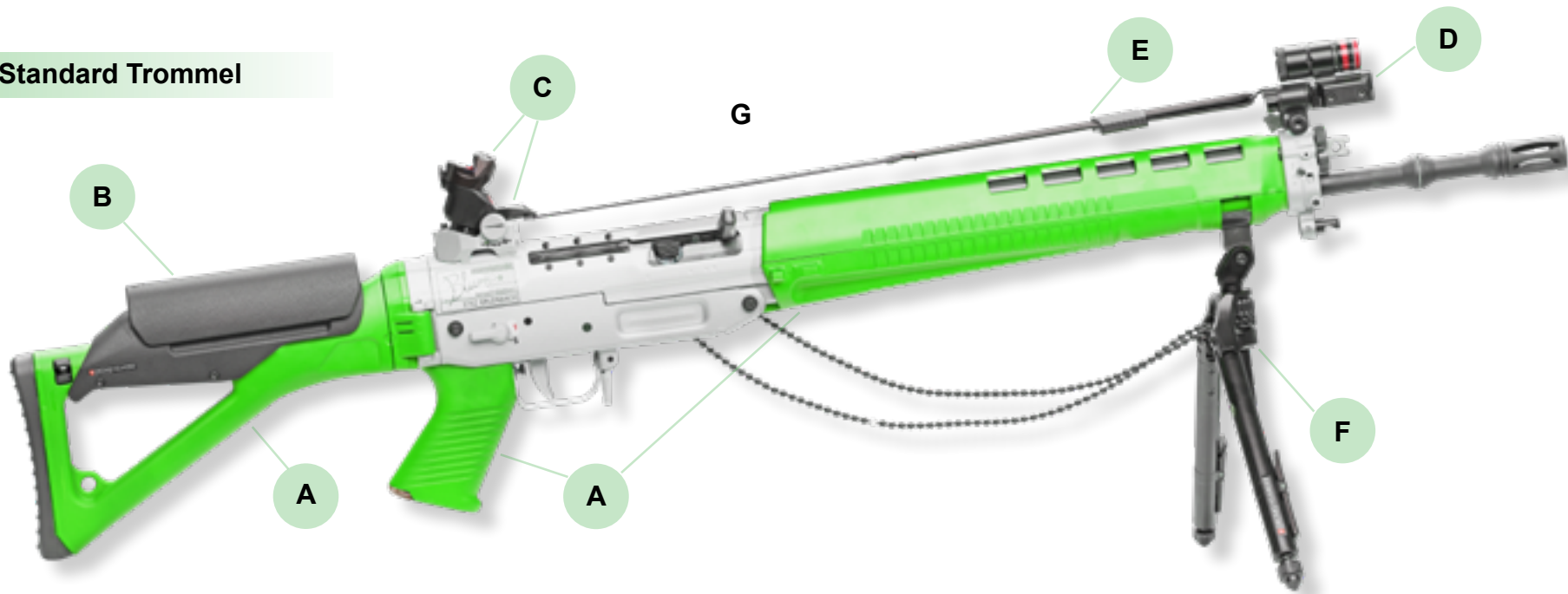

Linie Standard Trommel **exkl.** Visierteile und Zweibeinstütze **ab CHF 665.—**

A Kolben, Handschutz, Griff	SIG Sauer Stgw 90 Kolben, Handschutz, Griff Set	Art. Nr. 70.34.019476	Register 1
B Wangenauflage	G+E Stgw 90 Schafterhöhung fest Standardkolben Set	Art. Nr. 14.9743	Register 1
C Visierung Trommel	G+E Stgw 90 Irisblende, mit Filterkassette (2023) komplett mit 12 Farbfiltern G+E Diopteraufsatz	Art. Nr. 16.2140	Register 2
D Korn	G+E Stgw 90 Iris-Ringkorn einzeln	Art. Nr. 14.9720	Register 5
E Hitzeabweiser	G+E Stgw 90 Adapter mit Korntunnel M16	Art. Nr. 14.9756	Register 5
F Zweibeinstütze	G+E Stgw 90 Flimmerband mit Verstellschnalle	Art. Nr. 14.9716	Register 8
G Ladehebel	G+E Zweibeinstütze ERGONOMIC für Stgw 90	Art. Nr. 14.9750	Register 8
	Stgw 90 Ladegriffüberzug schwarz	Art. Nr. 16.2183	Register 8



Linie **Standard Diopter**

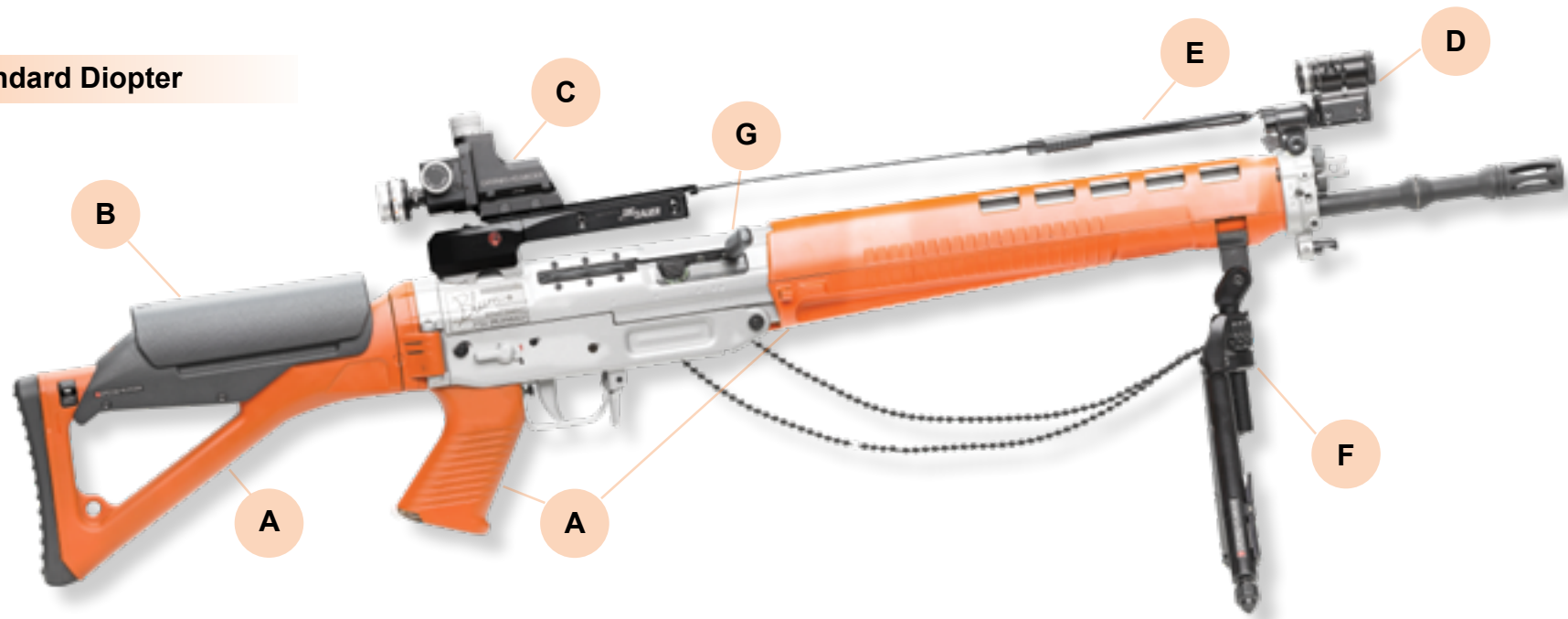

Linie Standard Diopter **exkl.** Visierteile und Zweibeinstütze **ab CHF 888.—**

A Kolben, Handschutz, Griff	SIG Sauer Stgw 90 Kolben, Handschutz, Griff Set	Art. Nr. 70.34.019475	Register 1
B Wangenauflage	G+E Stgw 90 Schafterhöhung fest Standardkolben Set	Art. Nr. 14.9743	Register 1
C Visierung Trommel	G+E Stgw 90 Diopterplatte	Art. Nr. 14.9739	Register 3
	G+E Diopter GRAND PRIX, RH, schwenkbar	Art. Nr. 16.1550	Register 3
D Korn	Centra Irisringkorn Quer M18, 2.3-4.3, 1.6 schwarz	Art. Nr. 16.3272	Register 7
	G+E Stgw 90 Adapter mit Korntunnel M18	Art. Nr. 14.9757	Register 5
E Hitzeabweiser	G+E Stgw 90 Flimmerband mit Verstellschnalle	Art. Nr. 14.9716	Register 8
F Zweibeinstütze	G+E Zweibeinstütze ERGONOMIC für Stgw 90	Art. Nr. 14.9750	Register 8
G Ladehebel	Stgw 90 Ladegriffüberzug schwarz	Art. Nr. 16.2183	Register 8



Linie Premium

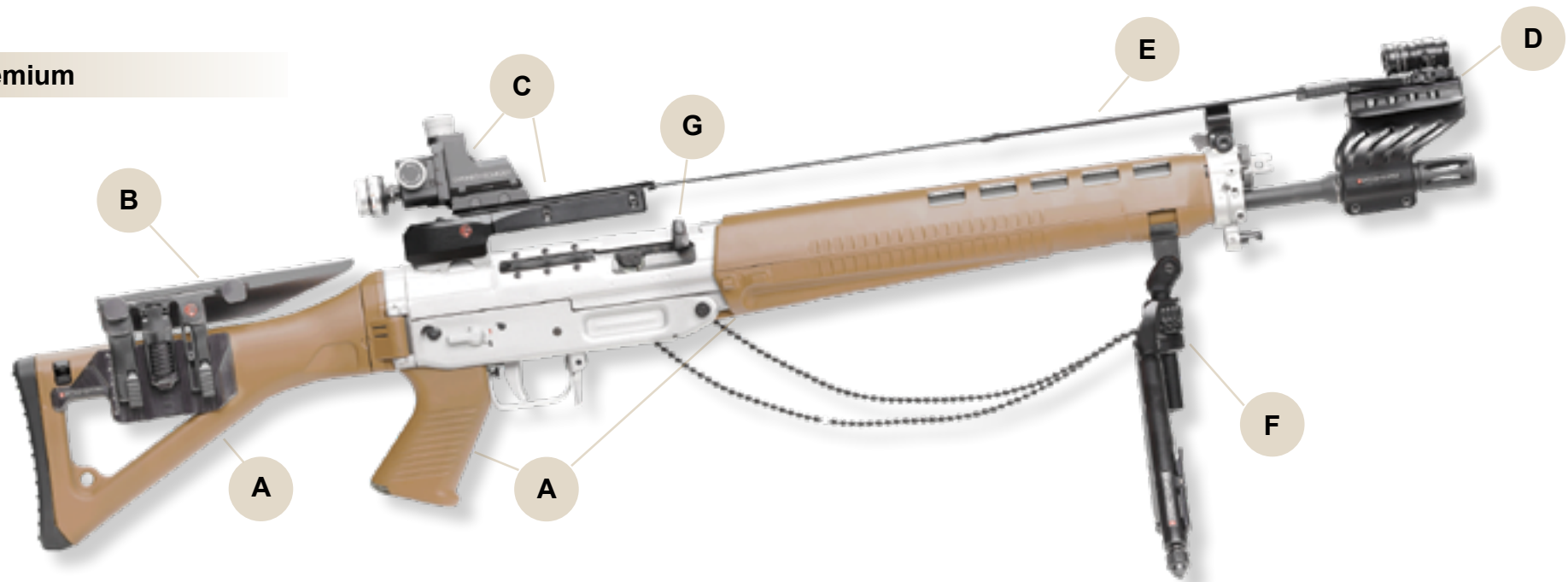

Linie Premium **exkl.** Visierteile und Zweibeinstütze **ab CHF 1'042.—**

A Kolben, Handschutz, Griff	SIG Sauer Stgw 90 Kolben, Handschutz, Griff Set	Art. Nr. 70.34.019460	Register 1
B Wangenaufgabe	G+E Stgw 90 Backenaufgabe verstellbar RH (auch links erhältlich)	Art. Nr. 14.9736	Register 1
C Visierung Trommel	G+E Stgw 90 Diopterplatte	Art. Nr. 14.9739	Register 3
	G+E Diopter GRAND PRIX, RH, schwenkbar	Art. Nr. 16.1550	Register 3
D Korn	G+E Stgw 90 Kornträger extended (ohne Korntunnel)	Art. Nr. 14.9742	Register 6
	Centra Irisringkorn Quer M18, 2.3-4.3, 1.6 schwarz	Art. Nr. 16.3272	Register 7
	G+E Korntunnel kurz mit Fuss M18, Länge 30 mm	Art. Nr. 14.9510	Register 6
E Hitzeabweiser	G+E Stgw 90 Flimmerband mit Verstellschnalle	Art. Nr. 14.9716	Register 8
F Zweibeinstütze	G+E Zweibeinstütze ERGONOMIC für Stgw 90	Art. Nr. 14.9750	Register 8
G Ladehebel	Stgw 90 Ladegriffüberzug schwarz	Art. Nr. 16.2183	Register 8



Kolben, Handschutz & Griff Set



[Art. Nr. 70.34.019460](#)
SIG Sauer Stgw 90 Kolben,
Handschutz, Griff
Set Farbe coyote

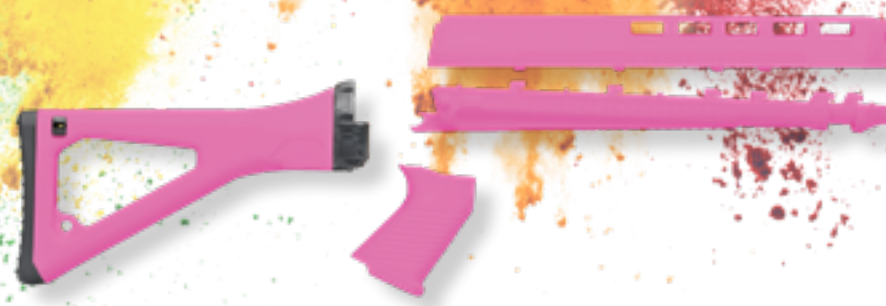

[Art. Nr. 70.34.019477](#)
SIG Sauer Stgw 90 Kolben,
Handschutz, Griff
Set Farbe pink



[Art. Nr. 70.34.019476](#)
SIG Sauer Stgw 90 Kolben,
Handschutz, Griff
Set Farbe zombiegrün



[Art. Nr. 70.34.019475](#)
SIG Sauer Stgw 90 Kolben,
Handschutz, Griff
Set Farbe orange

COLOUR UP!



[Art. Nr. 70.34.019478](#)

SIG Sauer Stgw 90 Kolben,
Handschutz, Griff

Set Farbe weiss



[Art. Nr. 70.34.021518](#)

SIG Sauer Stgw 90 Kolben,
Handschutz, Griff

Set Farbe schwarz



[Art. Nr. 70.34.021519](#)

SIG Sauer Stgw 90 Kolben,
Handschutz, Griff

Set Farbe olivgrün



[Art. Nr. 70.34.021520](#)

SIG Sauer Stgw 90 Kolben,
Handschutz, Griff

Set Farbe beige

Kolben



[Art. Nr. 70.34.553011](#)

SIG Sauer Stgw 90

Standardkolben grün



[Art. Nr. 70.34.553012](#)

SIG Sauer Stgw 90

Standardkolben schwarz

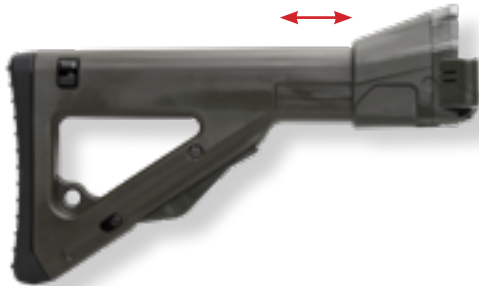

[Art. Nr. 70.34.553070.1](#)

SIG Sauer Stgw 90 **Schiebekolben** in
3 Stufen (Standard /-20mm/-40mm)

verstellbar grün,

komplette Montageeinheit



[Art. Nr. 70.34.553070](#)

SIG Sauer Stgw 90 **Schiebekolben** in
3 Stufen (Standard /-20mm/-40mm)

verstellbar schwarz,

komplette Montageeinheit

Schaftbacken/Wangenauflagen

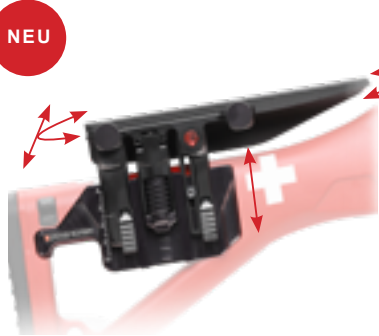

Art. Nr. [14.9736 RH](#)
[14.9736.1 LH](#)
G+E Stgw 90 Backenauf-
lage **Standardkolben**



Art. Nr. [14.9737 RH](#)
[14.9737.1 LH](#)
G+E Stgw 90 Backenauf-
lage **Schiebekolben**



Art. [14.9743](#)
G+E Stgw 90
Schafterhöhung fest
Standardkolben Set



Art. Nr. [14.9744](#)
G+E Stgw 90
Schafterhöhung fest
Schiebekolben Set



Art. Nr. [14.9745](#)
G+E Stgw 90
Schafterhöhung fest +20mm
Schiebekolben Set

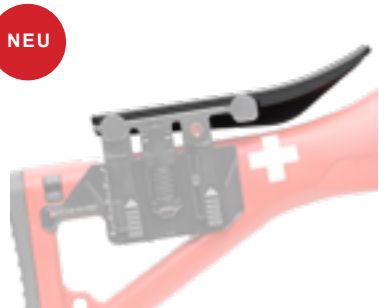

Art. Nr. [14.9733 RH](#)
[14.9733.1 LH](#)
G+E Stgw 90 Backen-
auflage **geschwungene**
Form für **Standard- und**
Schiebekolben



Art. Nr. [14.9746.01-14.9746.10](#)
G+E Stgw 90 Zusatzerhöhung
Standardkolben
Grössen (Höhen):
**2.5/5/7.5/10/12.5/15/17.5/
20/22.5 und 25mm**

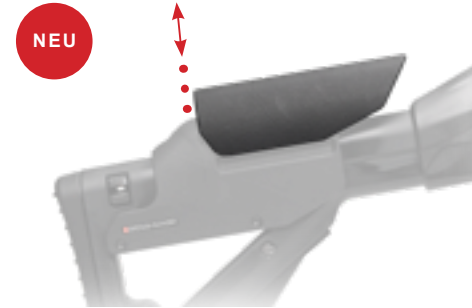

Art. Nr. [14.9747.01-14.9747.10](#)
G+E Stgw 90 Zusatzerhöhung
Schiebekolben
Grössen (Höhen):
**2.5/5/7.5/10/12.5/15/17.5/
20/22.5 und 25mm**

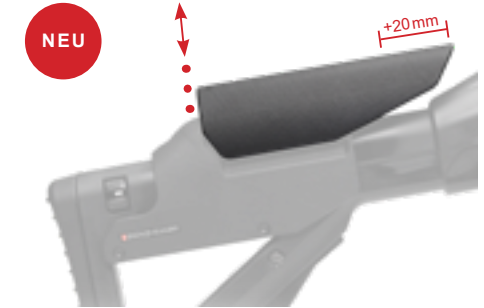

Art. Nr. [14.9748.01-14.9748.10](#)
G+E Stgw 90 Zusatzerhöhung
+20mm Schiebekolben
Grössen (Höhen):
**2.5/5/7.5/10/12.5/15/17.5/
20/22.5 und 25mm**

Ausgleich bis +/- 5 Dioptrien:

Dabei bleibt im gesamten Verstellbereich das Zielbild in der Größe unverändert und wie gewohnt... **allerdings scharf!**

Durch die Verwendung von neuen, hochbrechenden Glassorten ist es nun möglich, die sphärische Fehlsichtigkeit variabel auszugleichen, ohne eine optische Vergrößerung zu erzielen.

Achtung: die Diopteroptik 0,0 darf nur ohne Schiessbrille verwendet werden. Ansonsten könnte eine Vergrößerung des Zielbildes resultieren, was nicht gestattet ist!

International approved by



NEU

DIE DIOPTEROPTIK OHNE VERGRÖSSERUNG

[Art. Nr. 17.0090](#)

Gehmann 50300-0 Diopteroptik 0,0x

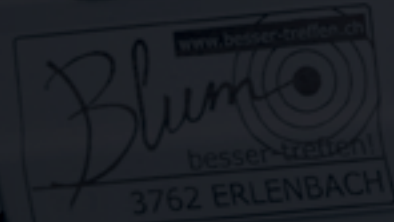

Irisblenden zu Visierträger



Montage



[Art. Nr. 14.9710](#)

G+E Stgw 90 Irisblende
Modell Match 90,
Verstellbereich 0.7-2.4 mm



Reinigung



[Art. Nr. 16.2140.1](#)

G+E Stgw 90 **Filterkassetten-Träger (2023)** komplett mit 12 Farbfiltern und Kassette, **ohne** Irisblende



[Art. Nr. 16.2140](#)

G+E Stgw 90 Filterkassette (2023) komplett mit 12 Farbfiltern, **mit Irisblende Match 90**



[Art. Nr. 14.9708](#)

G+E Stgw 90 Augenblende mit schwarz- u. milchig-matte Blenden für RH und LH



[Art. Nr. 14.9712](#)

G+E Stgw 90 Diopterschutzdeckel für Farbfilter+Irisblende



[Art. Nr. 16.7110](#)

G+E Stgw 90 Diopterschutzkappe, grün

NEU



[Art. Nr. 14.9713](#)

G+E Stgw 90 Diopteraufsatz (Linie Standard Trommel)

NEU



[Art. Nr. 14.9714](#)

G+E Stgw 90 Schutzdeckel zu Diopteraufsatz

Dioptr und Zubehör



[Art. Nr. 14.9739](#)

G+E Stgw 90 Dioptrplatte



Montage
Premium



Art. Nr. [16.1550 RH](#)

[16.1551 LH](#)

G+E Dioptr GRAND PRIX,
schwenkbar

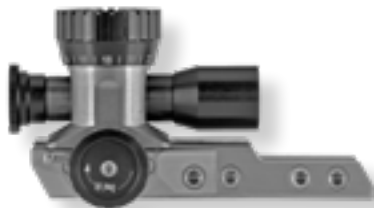

[Art. Nr. 16.4031 RH/LH](#)

Centra Dioptr Spy Cromo,
Chrom/Titan, Anschütz Rail,
Gegenlichtblende
(nur auf Premium möglich)

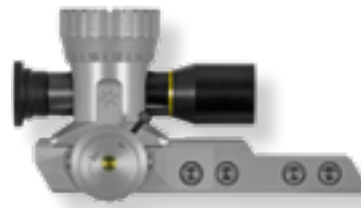

[Art. Nr. 16.4032 RH/LH](#)

Centra Dioptr Spy Long
silber
Anschütz Rail, Gegenlichtblende
(nur auf Premium möglich)



[Art. Nr. 16.4032.1 RH/LH](#)

Centra Dioptr Spy Long
schwarz, Anschütz Rail,
Gegenlichtblende
(nur auf Premium möglich)



[Art. Nr. 16.4033 RH/LH](#)

Centra Dioptr Spy Short
silber
Anschütz Rail, Gegenlichtblende
(nur auf Premium möglich)



[Art. Nr. 16.4033.1 RH/LH](#)

Centra Diopter Spy Short
schwarz Anschütz Rail,
Gegenlichtblende
(nur auf Premium möglich)



[Art. Nr. 16.4036 RH](#)

Centra Diopter Pro 57 LC
Rechts schwarz Anschütz Rail

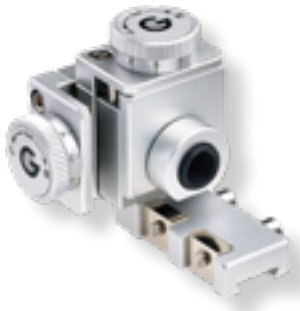

[Art. Nr. 17.3004 RH](#)

Gehmann 598 S Diopter silber



Art. Nr. [17.3000 RH](#)

[17.3000.1 LH](#)

Gehmann 590/590L Kompakt
Diopter aus Alu-Vollmaterial
passend für alle gängigen
Sportwaffen



[Art. Nr. 17.3004.1 RH](#)

Gehmann 598 S
Diopter gold limitierte Auflage



[Art. Nr. 17.3001 RH](#)

Gehmann 540 Champion,
Windfahnen-Diopter, verstell-
bare Iris mit neuer Fassung

Hülsenfänger

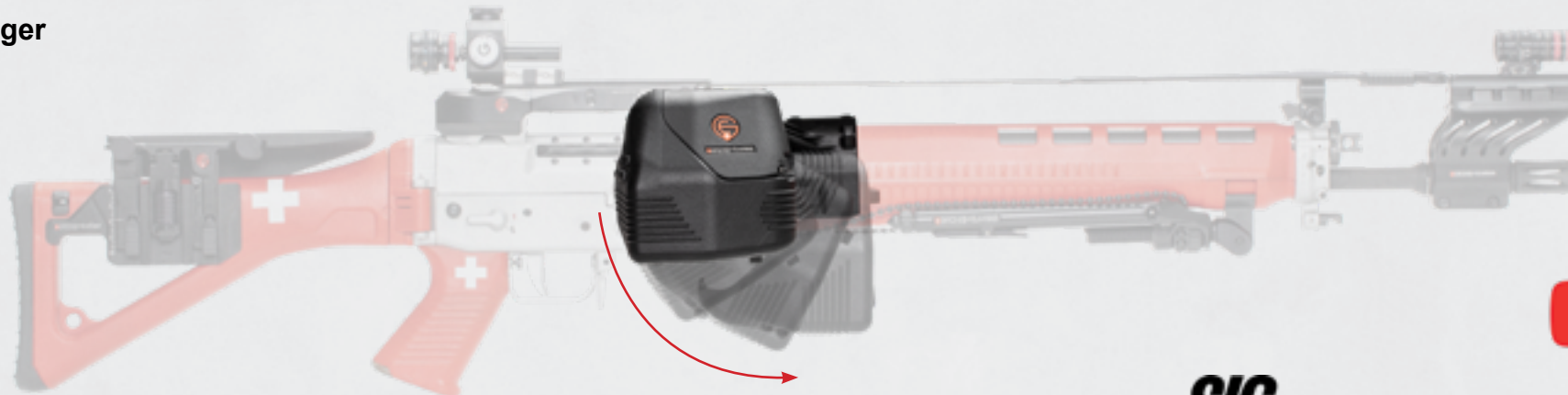

Art. Nr. [14.9707](#)
G+E/SIG SAUER Hülsenfänger



kompakte und leichte Konstruktion



Hülsenabweiser weiterhin separat nutzbar



einfaches Ausschwenken des Auffangkorbes

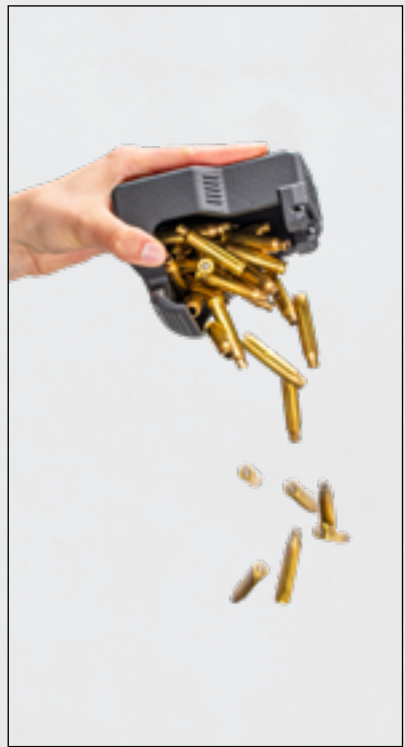

komfortables Entleeren der Hülsen



Visier-unabhängige Montage auf dem Handschutz

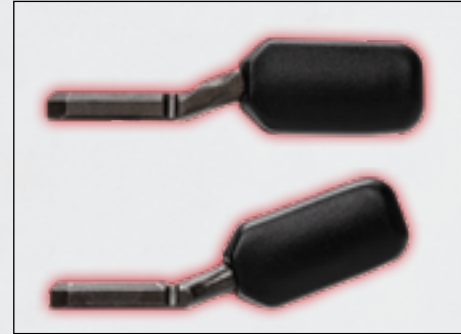

kompatibel zu allen Ladegriff-Formen



Kapazität für 40 Hülsen plus Sicherheits-Reserve

NEU



- M18-Gewinde
- Ø-Bereich 2.3-3.3
- Ringbreite 1.2
- ideal für die Stgw 90 Visierlinien
- passend für alle M18-Kornentunnel
- Vario: Balken oder Fadenkreuz umstellbar

DER OPTIMALE RING zur Visierlinienverlängerung Stgw 90

Linie Premium

Linie Standard Trommel

Linie Standard Diopter

Art. Nr. 16.3295 Centra Irisringkorn
Vario M18 2.3-3.3, 1.2 Rot

Irisblenden zu Diopter



[Art. Nr. 17.0010](#)

Gehmann 501 MC
Irisblende Multicolor
Ø 0.5-3.0



[Art. Nr. 17.0011](#)

Gehmann 510N
Irisblende
Ø 0.5-3.0



[Art. Nr. 17.0012](#)

Gehmann 510-S
Irisblende
Ø 0.5-3.0



[Art. Nr. 17.0020](#)

Gehmann 566
Irisblende 6 Farb-Filter
Ø 0.5-3.0



[Art. Nr. 17.0021](#)

Gehmann 566-S
Irisblende 6 Farb-Filter
Ø 0.5-3.0



[Art. Nr. 17.0050](#)

Gehmann 569
Irisblende 7 Farben +
Grau-/Blaustufen
Ø 0.5-3.0



[Art. Nr. 17.0060](#)

Gehmann 512MC
Irisblende 12 Farb-
Filter Multicolor
Ø 0.5-3.0



[Art. Nr. 17.0030](#)

Gehmann 550N
Irisblende
2-Polarisationsfilter
Ø 0.5-3.0



[Art. Nr. 17.0040](#)

Gehmann 563
Irisblende 6 Farb-Filter
und Poly
Ø 0.5-3.0



[Art. Nr. 17.0041](#)

Gehmann 565
Irisblende 6 Farb-
Filter und 2-Poly
Ø 0.5-3.0



[Art. Nr. 17.0070](#)

Gehmann 564
Irisblende 12 Farb-
Filter und Poly
Ø 0.5-3.0



[Art. Nr. 17.0080](#)

Gehmann 568
Irisblende 12 Farb-
Filter und 2-Poly
Ø 0.5-3.0



[Art. Nr. 17.0081](#)

Gehmann 568MC
Irisblende 12 Farb-
Filter und 2-Poly
Ø 0.5-3.0

NEU



[Art. Nr. 17.0090](#)

Gehmann 50300-0
Diopteroptik 0,0x
(nur Gehmann
kompatibel)

NEU



[Art. Nr. 17.0013](#)

Gehmann 530-0
Irisblende und Optik 0,0x
Ø 0.5-3.0

für SSV Wettbewerbe nicht gestattet (nicht im Hilfsmittelreglement)

NEU



[Art. Nr. 17.0024](#)

Gehmann 570-0
Irisblende 6 FF und
Optik 0,0x
Ø 0.5-3.0

NEU



[Art. Nr. 17.0043](#)

Gehmann 575-0
Irisblende 6FF, 2-Pol,
Optik 0.0
Ø 0.5-3.0

NEU



[Art. Nr. 17.0014](#)

Gehmann 530-579-0
Irisblende und Optik 0,0x
Ø 0.5-3.0

NEU



[Art. Nr. 17.0025](#)

Gehmann 570-579-0
Irisblende 6 FF und Optik
0,0x mit Zylinderlin-
sen-
system Optimal (ZLO)
Ø 0.5-3.0

NEU



[Art. Nr. 17.0042](#)

Gehmann 575-579-0
Irisblende 6 FF, 2-Pol,
Opt. 0,0 mit Zylinderlin-
sen-
system Optimal (ZLO)
Ø 0.5-3.0



[Art. Nr. 16.3014](#)
Centra Irisblende
Basic schwarz
Ø 0.8-1.8



[Art. Nr. 16.3014.1](#)
Centra Irisblende
Basic silber
Ø 0.8-1.8



[Art. Nr. 16.3014.2](#)
Centra Irisblende
Basic rot
Ø 0.8-1.8



[Art. Nr. 16.3014.3](#)
Centra Irisblende
Basic blau
Ø 0.8-1.8

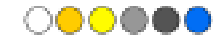

[Art. Nr. 16.3017](#)
Centra Irisblende Tiny
5 Farb-Filter schwarz
Ø 0.8-2.1



[Art. Nr. 16.3015](#)
Centra Irisblende Twin
10 Farb-Filter schwarz
Ø 0.8-1.8



[Art. Nr. 16.3015.1](#)
Centra Irisblende Twin
10 Farb-Filter silber
Ø 0.8-1.8



[Art. Nr. 16.3015.2](#)
Centra Irisblende Twin
10 Farb-Filter rot
Ø 0.8-1.8



[Art. Nr. 16.3015.3](#)
Centra Irisblende Twin
10 Farb-Filter blau
Ø 0.8-1.8



[Art. Nr. 16.3016](#)
Centra Irisbl. Competi-
tion 10 Farb-Poly-Filter
schwarz Ø 0.8-1.8



[Art. Nr. 16.3016.1](#)

Centra Irisblende
Competition 10 Farb-
Poly-Filter silber
Ø 0.8-1.8



[Art. Nr. 16.3016.2](#)

Centra Irisblende
Competition 10 Farb-
Poly-Filter rot
Ø 0.8-1.8



[Art. Nr. 16.3016.3](#)

Centra Irisblende
Competition 10 Farb-
Poly-Filter blau
Ø 0.8-1.8



[Art. Nr. 16.3018](#)

Centra Irisblende
Basic schwarz
Ø 0.5-3.0



[Art. Nr. 16.3018.1](#)

Centra Irisblende
Basic silber
Ø 0.5-3.0



[Art. Nr. 16.3018.2](#)

Centra Irisblende
Basic rot
Ø 0.5-3.0



[Art. Nr. 16.3018.3](#)

Centra Irisblende
Basic blau
Ø 0.5-3.0



[Art. Nr. 16.3019](#)

Centra Irisblende Filter
5 Farb-Filter schwarz
Ø 0.5-3.0



[Art. Nr. 16.3019.1](#)

Centra Irisblende Filter
5 Farb-Filter silber
Ø 0.5-3.0



[Art. Nr. 16.3019.2](#)

Centra Irisblende Filter
5 Farb-Filter rot
Ø 0.5-3.0



[Art. Nr. 16.3019.3](#)

Centra Irisblende Filter
5 Farb-Filter blau
Ø 0.5-3.0



[Art. Nr. 16.3020](#)

Centra Irisblende Pol
Poly-Filter schwarz
Ø 0.5-3.0



[Art. Nr. 16.3020.1](#)

Centra Irisblende Pol
Poly-Filter silber
Ø 0.5-3.0



[Art. Nr. 16.3021](#)

Centra Irisblende Combi
5 Farb-Poly-Filter schwarz
Ø 0.5-3.0



[Art. Nr. 16.3021.1](#)

Centra Irisblende Combi
5 Farb-Poly-Filter silber
Ø 0.5-3.0



[Art. Nr. 16.3021.2](#)

Centra Irisblende Combi
5 Farb-Poly-Filter rot
Ø 0.5-3.0



[Art. Nr. 16.3021.3](#)

Centra Irisblende Combi
5 Farb-Poly-Filter blau
Ø 0.5-3.0

ERGONOMIC

DIE ULTIMATIVE ZWEIBEINSTÜTZE

Art. Nr. 14.9750 G+E Zweibeinstütze
ERGONOMIC für Stgw 90

- die universale Zweibeinstütze
- für Stgw 90, Stgw 57, Karabiner und Standardgewehr
- Höhenverstellung im Anschlag mit Blick auf's Ziel
- selbstzentrierender Drehausgleich
- Schnell- und Feinverstellung
- stabil im Stand



Montage



Trailer

Korn

kompatibel Linie Basis



[Art. Nr. 14.9700](#)
G+E Stgw 90 **Iris-Ringkorn** „ohne“
Augenblende



[Art. Nr. 14.9700.1](#)
G+E Stgw 90 **Iris-Ringkorn** „mit“
Augenblende



[Art. Nr. 14.9700.4](#)
G+E Stgw 90 **DUO**
Ringkorn „ohne“
Augenblende



[Art. Nr. 14.9700.5](#)
G+E Stgw 90 **DUO**
Ringkorn „mit“
Augenblende



[Art. Nr. 14.9700.2](#)
G+E Stgw 90
Square Ringkorn
„ohne“ Augenblende



[Art. Nr. 14.9700.3](#)
G+E Stgw 90
Square Ringkorn
„mit“ Augenblende

kompatibel Linie Standard Diopter

kompatibel Linie Standard Trommel

NEU



[Art. Nr. 14.9740](#)
G+E Stgw 90
Kornadapter

NEU



[Art. Nr. 14.9756](#)
G+E Stgw 90
Kornadapter mit
Korntunnel M16
(für aktuelle
Stgw 90-Korne)

NEU

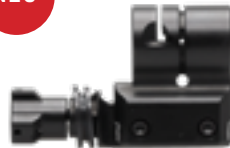

[Art. Nr. 14.9757](#)
G+E Stgw 90
Kornadapter mit
Korntunnel M18

NEU



[Art. Nr. 14.9758](#)
G+E Stgw 90
Korntunnel M16
(für aktuelle
Stgw 90-Korne)

NEU



[Art. Nr. 14.9759](#)
G+E Stgw 90
Korntunnel M18

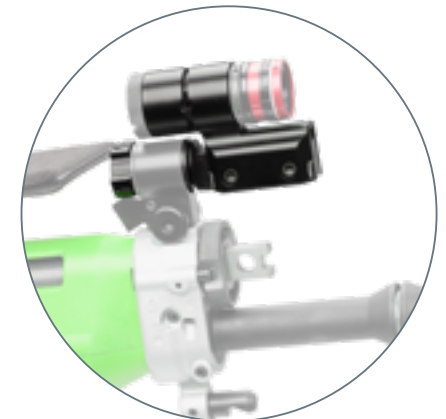

Korn Zubehör

kompatibel Linie **Basis**

kompatibel Linie **Standard Trommel**

kompatibel Linie **Standard Diopter**



[Art. Nr. 14.9720](#)

G+E Stgw 90 **Standard**
Iris-Ringkorn einzeln



[Art. Nr. 14.9720.2](#)

G+E Stgw 90 **DUO**
Irisingkorn einzeln



[Art. Nr. 14.9720.1](#)

G+E Stgw 90 **Square**
Irisingkorn einzeln



[Art. Nr. 14.9719](#)

Ringkornschutz (neu für
Basis und für Standard Linien)



Montage
Ringkorn



[Art. Nr. 14.9730 1.0](#)

G+E Stgw 90 Glasring-
korn TOP SIGHT
Ø 1.7 - 2.9



[Art. Nr. 14.9731 1.1](#)

G+E Stgw 90 Glasring-
korn TOP SIGHT
Ø 1.7 - 2.7



[Art. Nr. 14.9709](#)

G+E Stgw 90 Adapterschutzdeckel

Korn und Korn Zubehör

kompatibel Linie Premium

NEU



[Art. Nr. 14.9742](#)

G+E Stgw 90 Kornträger
extended inkl. Kornträgerschutz

NEU



[Art. Nr. 14.9728](#)

G+E Adapterring M16x0.5 auf
M18x0.5 für Single, Square und Duo

NEU

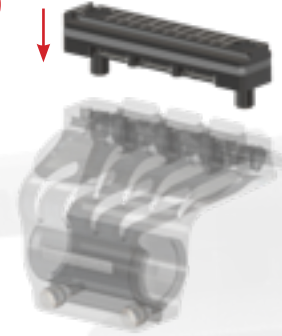

[Art. Nr. 14.9742.1](#)

G+E Schnellwechselplatte komplett mit
Thermosperre (6 Stk. im Lieferumfang)

NEU



[Art. Nr. 14.9711](#)

G+E Kornträgerschutz
mit Kordel

NEU



[Art. Nr. 14.9711.1](#)

G+E Kordel zu Konträgerschutz

NEU

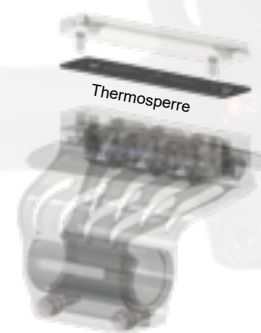

[Art. Nr. 14.9722.1](#)

G+E **Thermosperre 1 mm**

Die **Thermosperre** dient als Höhenausgleich, wenn der Diopter-Vestellbereich für die Höhe nicht etwa mittig ist. Ab Werk sind 3 mm montiert. 1 mm entspricht ca. 50 cm auf der Scheibe. Der maximale Bereich beträgt 0 mm bis 6 mm.



Montage
Premium

kompatibel Linie Premium

NEU

[Art. Nr. 14.9741](#)

G+E Stgw 90 Kornfussspanner
horizontal

NEU

[Art. Nr. 14.9741.1](#)

G+E Stgw 90 Kornfussspanner
vertikal

NEU

[Art. Nr. 14.9734](#)

G+E Stgw 90 Kornfussspanner
horizontal mit Tunnel

NEU

[Art. Nr. 14.9734.1](#)

G+E Stgw 90 Kornfussspanner
vertikal mit Tunnel

[Art. Nr. 14.9500](#)

G+E Kornfuss M18 für G+E
(11mm Prisma-schiene)

[Art. Nr. 14.9513](#)

G+E Korntunnelhülse **kurz**
30mm, M18

[Art. Nr. 14.9523](#)

G+E Korntunnelhülse
lang 34mm, M18, schwarz

[Art. Nr. 14.9510](#)

G+E Korntunnel **kurz** mit Fuss
M18, Länge 30mm

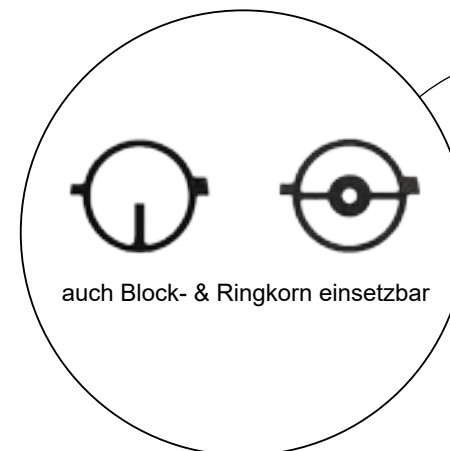

auch Block- & Ringkorn einsetzbar

[Art. Nr. 14.9520](#)

G+E Korntunnel **lang** mit Fuss
M18, Länge 34mm

Korn Visierung



[Art. Nr. 17.1010](#)

Gehmann 535
Irisingkorn Duo „two
in one“ Balken
innen-Ø 2.4-4.4 mm
ausßen-Ø 7.0-9.0 mm
(nicht für Standard
Trommel)



[Art. Nr. 17.1011](#)

Gehmann 536
Glasringkorn Duo „two
in one“ Glas
innen-Ø 2.4-4.4 mm
ausßen-Ø 7.0-9.0 mm
(nicht für Standard
Trommel)



[Art. Nr. 17.1012](#)

Gehmann 537
Irisingkorn Duo „two
in one“ Faden
innen-Ø 2.4-4.4 mm
ausßen-Ø 7.0-9.0 mm
(nicht für Standard
Trommel)



[Art. Nr. 17.1020](#)

Gehmann 520A
Irisingkorn M18,
Balken
Ø 2.4-4.4 mm
Gehäuse in schwarz



[Art. Nr. 17.1021](#)

Gehmann 520B
Irisingkorn M18,
Balken
Ø 4.0-6.0 mm
Gehäuse in schwarz



[Art. Nr. 17.1022](#)

Gehmann 520C
Irisingkorn M18,
Balken
Ø 2.9-4.9 mm
Gehäuse in schwarz



[Art. Nr. 17.1000](#)

Gehmann 521FQ
Irisingkorn Duo
„Zylinder“ M18
innen-Ø 2.9-4.9 mm
ausßen-Ø 7.0-9.0 mm



[Art. Nr. 17.1060](#)

Gehmann 528A
Irisingkorn M18,
FQ Querbalken
oder Fadenkreuz
Ø 2.4-4.4 mm



[Art. Nr. 17.1061](#)

Gehmann 528B
Irisingkorn M18,
FQ Querbalken
oder Fadenkreuz
Ø 4.0-6.0 mm



[Art. Nr. 17.1062](#)

Gehmann 528C
Irisingkorn M18,
FQ Querbalken
oder Fadenkreuz
Ø 2.9-4.9 mm



[Art. Nr. 17.1001](#)

Gehmann 521G
Glasringkorn Duo
„Zylinder“ M18
innen-Ø 2.9-4.9 mm
ausßen-Ø 7.0-9.0 mm



[Art. Nr. 16.3272](#)

Centra Irisringkorn
Quer M18, schwarz
Ringbreite 1.6 mm
Ø 2.3-4.3 mm



[Art. Nr. 16.3273](#)

Centra Irisringkorn
Quer M18, schwarz
Ringbreite 1.6 mm
Ø 2.8-4.8 mm



[Art. Nr. 16.3274](#)

Centra Irisringkorn
Quer M18, schwarz
Ringbreite 2.0 mm
Ø 2.8-4.8 mm



[Art. Nr. 16.3275](#)

Centra Irisringkorn
Quer M18, schwarz
Ringbreite 2.0 mm
Ø 3.8-5.8 mm



[Art. Nr. 16.3276](#)

Centra Irisringkorn
Vario M18, schwarz
Ringbreite 1.6 mm
Ø 2.3-4.3 mm



[Art. Nr. 16.3277](#)

Centra Irisringkorn
Vario M18, schwarz
Ringbreite 1.6 mm
Ø 2.8-4.8 mm



[Art. Nr. 16.3278](#)

Centra Irisringkorn
Vario M18, schwarz
Ringbreite 2.0 mm
Ø 2.8-4.8 mm



[Art. Nr. 16.3279](#)

Centra Irisringkorn
Vario M18, schwarz
Ringbreite 2.0 mm
Ø 3.8-5.8 mm



[Art. Nr. 16.3282](#)

Centra Irisringkorn
Glas M18, schwarz
Ringbreite 1.2 mm
Ø 2.3-3.3 mm



[Art. Nr. 16.3295](#)

Centra Irisringkorn
Vario M18, rot
Ringbreite 1.2 mm
Ø 2.3-3.3 mm



[Art. Nr. 16.3288](#)

Centra Irisringkorn
Glas M18, schwarz
Ringbreite 1.2 mm
Ø 2.8-3.8 mm



[Art. Nr. 16.3289](#)

Centra Irisringkorn
Glas M18, schwarz
Ringbreite 1.2 mm
Ø 3.8-4.8 mm



[Art. Nr. 16.3291](#)

Centra Irisringkorn
Glas M18, schwarz
Ringbreite 1.6 mm
Ø 1.8-4.3 mm



[Art. Nr. 16.3292](#)

Centra Irisringkorn
Glas M18, schwarz
Ringbreite 1.6 mm
Ø 2.8-4.8 mm



[Art. Nr. 16.3293](#)

Centra Irisringkorn
Glas M18, schwarz
Ringbreite 2.0 mm
Ø 2.8-4.8 mm



[Art. Nr. 16.3294](#)

Centra Irisringkorn
Glas M18, schwarz
Ringbreite 2.0 mm
Ø 3.8-5.8 mm



[Art. Nr. 16.3284](#)

Centra Irisringkorn
Duo Vario M18 mit Fuss
schwarz
Ø 2.8-4.8 mm
Ø 6.4-9.0 mm



[Art. Nr. 16.3284.1](#)

Centra Irisringkorn
Duo Glas M18 mit Fuss
schwarz
Ø 2.8-4.8 mm
Ø 6.4-9.0 mm

«Wo alles begann»

«Where everything began»



Emil Grünig wird Olympiasieger in London 1948



Emil Grünig wins olympic gold in London 1948



Kurt Grünig's Onkel Walther Lienhard gründete 1922 die Waffenfabrik W. Lienhard.

Kurt Grünig und Heinz Elmiger übernahmen 1962 die Fabrikation und gründeten die Grünig + Elmiger AG.

Kurt Grünig's uncle Walther Lienhard founded the arms factory W. Lienhard in 1922.

Kurt Grünig and Heinz Elmiger took over production in 1962 and founded Grünig + Elmiger AG.



Inside Grünig + Elmiger AG

In unserer hauseigenen und topmodernen Schiessanlage schiessen wir auf 50 m Schussbilder mit dem Ziel, für Sie die optimale Munition zu finden. Digitale Auswertungen der Schiessresultate ermöglichen eine exakte Feinabstimmung. In unserer Büchsenmacherei können die Waffen bei Bedarf auf eine korrekte Funktion überprüft und falls nötig repariert werden.

In our own shooting range we shoot at 50 m with the aim to find the optimal ammunition for you. Digital evaluations of the shooting results allow an exact fine tuning. In our in-house gunsmith's workshop the rifles can be checked for correct function and repaired if necessary.

Diverses Zubehör



[Art. Nr. 14.9715](#)
G+E Stgw 90
Flimmerabweiser



Montage



[Art. Nr. 14.9716](#)
G+E Stgw 90
Flimmerband mit Verstell schnalle



[Art. Nr. 16.2468](#)
SIG Sauer
Zweibeinstütze
Stgw 90 ME
verstellbar, **schwarz**



[Art. Nr. 16.2469](#)
SIG Sauer
Zweibeinstütze
Stgw 90 ME
verstellbar, **grün**



[Art. Nr. 14.9750](#)
G+E Zweibeinstütze
ERGONOMIC für
Stgw 90



[Art. Nr. 70.34.010712](#)
SIG Sauer Stgw 90
Griff, **schwarz**



[Art. Nr. 70.34.010708](#)
SIG Sauer Stgw 90
Griff, **olivgrün**



[Art. Nr. 24.5574](#)
Hogue Griff Gummi SIG
Sauer 55X/Stgw90 ohne
Fingermulden



[Art. Nr. 70.34.710205](#)
SIG Sauer Stgw 90
Holzgriff SAT konform



[Art. Nr. 16.7102](#)
G+E Stgw 90
Messer, schwarz



Montage



Montage



Montage



Montage

NEU



[Art. Nr. 14.9719](#)
G+E Ringkornschutz
(neu für Basis und für
Standard Linien)

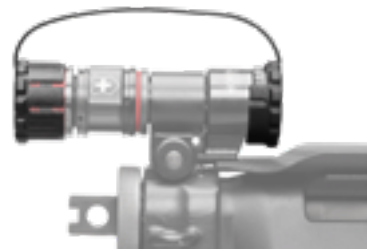

[Art. Nr. 14.9709](#)
G+E Stgw 90 Adapter-
schutzdeckel



[Art. Nr. 14.9712](#)
G+E Stgw 90 Diopter-
schutzdeckel



[Art. Nr. 14.9708](#)
G+E Stgw 90 Augen-
blende mit schwarz- u.
milchig-matte Blenden für
RH und LH



[Art. Nr. 14.9717](#)
G+E Stgw 90 Laufdeckel



Montage



[Art. Nr. 14.9725](#)
G+E Stgw 90 Filter-
FS **gelb** zu Ringkorn



[Art. Nr. 14.9726](#)
G+E Stgw 90 Filter-
FS **rot** zu Ringkorn



[Art. Nr. 14.9723](#)
G+E Stgw 90 Libelle
zu Ringkorn



[Art. Nr. 16.3811.18](#)
Centra Polarizer
M18, 2-Pol-Filter-
Scheiben für Korn-
tunnel



[Art. Nr. 70.34.34556201](#)
SIG Sauer Stgw90
Magazin 20 Schuss
mit Nocken (Nur mit
Sonderbewilligung seit
15.8.2019)



[Art. Nr. 70.34.556251](#)
SIG Sauer Stgw90
Magazin 10 Schuss
ohne Nocken



[Art. Nr. 14.9609](#)
G+E Hightech Box
für TOP SIGHT
M18 für 10 Stück



[Art. Nr. 14.9735](#)
G+E Stgw 90 Hightech Box
für TOP SIGHT
M16 für 10 Stück



Montage



[Art. Nr. 16.2183](#)
Stgw 90 Ladegriff-
überzug schwarz
(Diverse Farben
erhältlich)



[16.2183.1](#)

[16.2183.2](#)



[16.2183.3](#)

[16.2183.4](#)



[16.2183.5](#)

[16.2183.6](#)



[16.2183.7](#)



Montage



[Art. Nr. 14.9705](#)

G+E Stgw 90 **Set-Box-Basic**
Iris-Ringkorn mit Adapter
div. Zubehör



[Art. Nr. 14.9705.1](#)

G+E Stgw 90 **Set-Box-Basic+**
Iris-Ringkorn mit Adapter div.
Zubehör, Augenblende



[Art. Nr. 14.9706](#)

G+E Stgw 90 **Set-Box-Maxi**
Iris-Ringkorn mit Adapter div.
Zubehör, Farbfilterkassette,
Irisblende



[Art. Nr. 14.9706.1](#)

G+E Stgw 90 **Set-Box-Maxi+**
Iris-Ringkorn mit Adapter
div. Zubehör, Farbfilterkassette,
Irisblende, Augenblende



[Art. Nr. 14.9705.4](#)

G+E Stgw 90 **Set-Box-Basic**
DUO-Ringkorn mit Adapter
div. Zubehör

[Art. Nr. 14.9705.5](#)

G+E Stgw 90 **Set-Box-Basic+**
DUO-Irisringkorn mit Adapter
div. Zubehör, Augenblende

[Art. Nr. 14.9706.4](#)

G+E Stgw 90 **Set-Box-Maxi**
DUO-Irisringkorn mit Adapter
div. Zubehör, Farbfilterkassette,
Irisblende

[Art. Nr. 14.9706.5](#)

G+E Stgw 90 **Set-Box-Maxi+**
DUO-Irisringkorn mit Adapter
div. Zubehör, Farbfilterkassette,
Irisblende, Augenblende



[Art. Nr. 14.9705.2](#)

G+E Stgw 90 **Set-Box-Basic**
Square-Ringkorn mit Adapter
div. Zubehör

[Art. Nr. 14.9705.3](#)

G+E Stgw 90 **Set-Box-Basic+**
Square-Irisringkorn mit Adapter
div. Zubehör, Augenblende

[Art. Nr. 14.9706.2](#)

G+E Stgw 90 **Set-Box-Maxi**
Square-Irisringkorn mit Adapter
div. Zubehör, Farbfilterkassette,
Irisblende

[Art. Nr. 14.9706.3](#)

G+E Stgw 90 **Set-Box-Maxi+**
Square-Irisringkorn mit Adapter
div. Zubehör, Farbfilterkassette,
Irisblende, Augenblende



Öle, Fette & Reiniger Stgw 90/ Stgw 57



[Art. Nr. 42.1106](#) 10g
[Art. Nr. 42.1107](#) 70g

Abzugsmechanik

Ballistol GunCer Keramik-Waffenfett, Tube oder Dose



[Art. Nr. 42.1100](#) 50 ml
[Art. Nr. 42.1102](#) 200 ml

Schmierung bewegl. Waffenteile

Ballistol GunCer Keramik-Waffenöl Spray



[Art. Nr. 42.1065](#) 50 ml
[Art. Nr. 42.1070](#) 200 ml
[Art. Nr. 42.1075](#) 400 ml

Konservierungsspray synthetisch

Ballistol Gunex Spezial-Waffenöl Spray



[Art. Nr. 42.1079](#) 100 ml
[Art. Nr. 42.1080](#) 500 ml

Konservierungs-Öl synthetisch

Ballistol Gunex Spezial-Waffenöl



[Art. Nr. 42.1196](#) 50 ml
[Art. Nr. 42.1195](#) 200 ml

Ballistol **Kaltentfetter** Spray



[Art. Nr. 42.1020](#) 50 ml
[Art. Nr. 42.1022](#) 500 ml
[Art. Nr. 42.1024](#) 5l
[Art. Nr. 42.1026](#) 10l

Ballistol **Universalöl (mineralisch)**



[Art. Nr. 42.1005](#) 50 ml
[Art. Nr. 42.1012](#) 200 ml
[Art. Nr. 42.1013](#) 400 ml

Ballistol **Universalöl-Spray (mineralisch)**



[Art. Nr. 42.1185.6](#) 65 ml
[Art. Nr. 42.1186](#) 1000 ml

Ballistol Robla Solo MIL **Laufreiniger (chemisch)**



[Art. Nr. 42.6224](#) 30 ml

Schmierung Feder
Celen Quimica Slippery Gun Oil



[Art. Nr. 42.6223](#) 300 ml

Schmierung bewegl. Waffenteile
Interflon Fin Grease Spray

Putzstöcke Stgw 90

KALIBEREMPFEHLUNGEN

Waffenkaliber	Filz-Größe	Patch-Größe	Patch-Adapter in Ø	Werg-Adapter in Ø	Flex Clean
4 mm M 20	.17	-	-	-	-
.17 / 4,5 mm / .177	.17	-	-	4 mm	-
.22 / .222 / .223 / .224 / 5,5 mm / 5,56 mm / 5,6 mm / .228	.22	21 mm	5,5 mm	5 mm	.22/.24
.243 / 6 mm	.260	21 mm	6 mm	5 mm	.22/.24
6,35 mm / .25	.260	21 mm	6 mm	5 mm	.25/.28
6,5 mm / 25-06 (= .257) / .260 / .264	.260	21 mm	6,5 mm	6 mm	.25/.28
6,8 mm / .270	.280	21 mm	6,5 mm	6 mm	.25/.28
7 mm / .280 / .284	.280	21 mm	7,0 mm	6 mm	.25/.28
7,5 mm / 7,62 mm / 30-06 / .300 / .308	.308	35 mm	7,5 mm	7 mm	.30/.32
7,64 mm / 7,65 mm / .32	.32	35 mm	7,5 mm	7 mm	.30/.32
7,92 mm / 8 mm / .325 / .327	.32	35 mm	8,0 mm	7 mm	.30/.32
8,5 mm / .338	.38	35 mm	8,5 mm	8 mm	.33/.38
9 mm / .357 / 9,3 mm / .375 / .38	.38	35 mm	9,0 mm	8 mm	.33/.38
.40 / .404 / .405 / 10,3 mm / .408 / .41 / .416	.40	35 mm	9,0 mm	9 mm	-
.43 / .44	.45	35 mm	Kal. .44	10 mm	.45
.45 / .458 / .460 / .475 / .480	.45	35 mm	Kal. .45	10 mm	.45
.50 / 12,7 mm	.50	-	-	-	.50
18,53 mm (für Flinten)	12 GA	-	-	-	12 GA
16,84 mm (für Flinten)	16 GA	-	-	-	16 GA
15,63 mm (für Flinten)	20 GA	-	-	-	20 GA



[Art. Nr. 42.3075](#)

ERZINGER Putzstock für Stgw 90 Holzgriff

Kal. 5.6 mm GP90

Länge 75 cm

Gewinde M4x0.5

Ø5 mm

Bürsten Stgw 90



normale Verschmutzung

[Art. Nr. 42.2980](#)

ERZINGER Bronzebürste
Kal. 5.6mm GP90
Innen-Gewinde M4x0.5



normale Verschmutzung

[Art. Nr. 42.3020](#)

ERZINGER Bronzebürste
Kal. 5.6mm GP90
Innen-Gewinde 1/8"



normale Verschmutzung

[Art. Nr. 42.7030.56](#)

Stil Bronzebürste
Kal. 5.6mm GP90
Innen-Gewinde 1/8"



starke Verschmutzung

[Art. Nr. 42.3015](#)

ERZINGER Stahldrahtbürste
Kal. 5.6mm GP90
Innen-Gewinde M4x0.5



Patronenlager

[Art. Nr. 42.3017](#)

ERZINGER Bronzebürste
Patronenlager Stgw 90
Innen-Gewinde M4x0.5



Gasrohr

[Art. Nr. 42.3016](#)

ERZINGER Stahldrahtbürste
Gasrohr Stgw 90
Innen-Gewinde M4x0.5



Konservierung

[Art. Nr. 42.3018](#)

ERZINGER Fettbürste
Kal. 5.6mm GP90
Innen-Gewinde M4x0.5



Konservierung

[Art. Nr. 42.7040.56](#)

Stil Nylonbürste
Kal. 5.6mm GP90
Innen-Gewinde 1/8"



Set

[Art. Nr. 42.7080.56](#)

Stil Bürstenset
Kal. 5.6mm GP90
Innen-Gewinde 1/8"

Kolben & Adapter Stgw 90



für Gewehrputzstreifen

[Art. Nr. 42.2990](#)

ERLA Wischkolben Stgw 90
Kal. 5.6 mm GP90
Innen-Gewinde M4x0.5



für Gewehrputzstreifen

[Art. Nr. 42.7062.56](#)

Stil Messingwischkolben
Kal. 5.6 mm GP90
Innen-Gewinde 1/8"



für Hanf

[Art. Nr. 42.7060.56](#)

Stil Aluwischkolben
Kal. 5.6 mm GP90
Innen-Gewinde 1/8"



für Filzreiniger

[Art. Nr. 42.1410](#)

Ballistol Filz-Adapter für 3 Filze
Kal. 5.6 mm GP90
Innen-Gewinde 1/8"
Aussen-Gewinde M5



für Patches

[Art. Nr. 42.1393.55](#)

Ballistol Patch-Adapter
Alu Kal. 5.6 mm GP90
Ø 5.5 mm



Gewindeadapter

[Art. Nr. 42.1415.10](#)

Ballistol Gewinde Adapter
Kal. 5.6 mm GP90
M4 innen auf 1/8" innen



für Filzreiniger

[Art. Nr. 42.6601.0](#)

G+E Stgw 90 Spezial-
adapter für Putzzeug
Kal. 5.6 mm GP90
Innen-Gewinde M4x0.5



für Filzreiniger

[Art. Nr. 42.6601.1](#)

G+E Spezialadapter für
Stgw 90 Stahlbürste
Kal. 5.6 mm GP90
Innen-Gewinde 1/8"



zu Paul Clean Patch

[Art. Nr. 42.6221](#)

Patch Adapter GP 90/.22
für Putzstock
zu PaulClean Roll Patch
Innen-Gewinde M4x0.5

Filze, Schnüre & Sets Stgw 90

Reinigung / Konservierung



[Art. Nr. 42.1375.22](#) **60 Stk**
[Art. Nr. 42.1376.22](#) **300 Stk**
 Ballistol **Filzreiniger Klassik**
 Kal. 5.6mm GP90

Vorreinigung



[Art. Nr. 42.1380.22](#) **60 Stk**
[Art. Nr. 42.1381.22](#) **300 Stk**
 Ballistol **Filzreiniger Spezial**
 Kal. 5.6mm GP90

Reinigung / Konservierung



[Art. Nr. 42.1390.21](#) **150 Stk**
[Art. Nr. 42.1391.21](#) **500 Stk**
 Ballistol **Mikrofaser-Patch**
 Kal. 5.6mm GP90
 rund 21mm

Reinigung / Konservierung



[Art. Nr. 42.3100](#)
 G+E Gewehrputzstreifen Original
 Kal. 5.6mm GP90



[Art. Nr. 16.2195](#)
 VNO Stgw90 Putzböckli komplett
 inkl. Brett



[Art. Nr. 70.34.558793](#)
 SIG Sauer Stgw 90 Putzzeug
 komplett Kal. 5.6mm GP90



[Art. Nr. 42.7336](#)
 Stil Reinigungsschnur BoreBlitz
 Kal. 5.6mm GP90
 inkl. Ölflacon 25ml und Handgriff

Reinigung / Konservierung



[Art. Nr. 42.6220](#)
 PaulClean Roll Patch
 (Rolle à 250Stk)

VERHÄLTNIS ZWISCHEN SCHEIBEN- UND RINGGRÖSSE

1/4 Scheibengröße (bei optimaler Sicht)
= 125% Zielfläche weiss

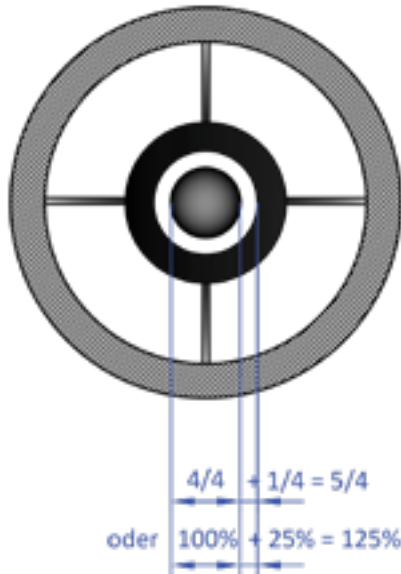

1/2 Scheibengröße (bei mittlerer Sicht)
= 150% Zielfläche weiss

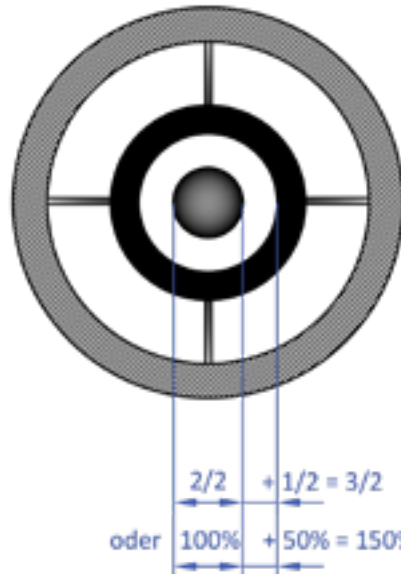

1/3 Scheibengröße (bei guter Sicht)
= 133% Zielfläche weiss

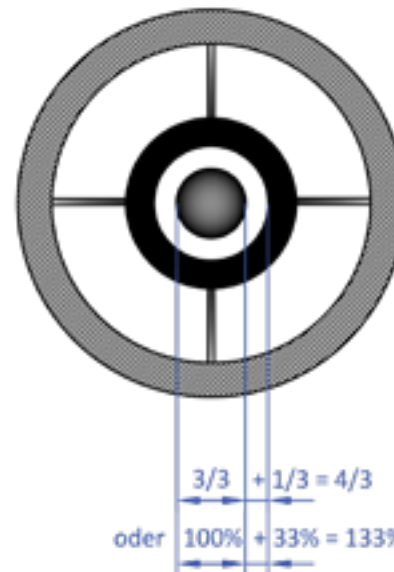

3/4 Scheibengröße (bei schlechter Sicht)
= 175% Zielfläche weiss

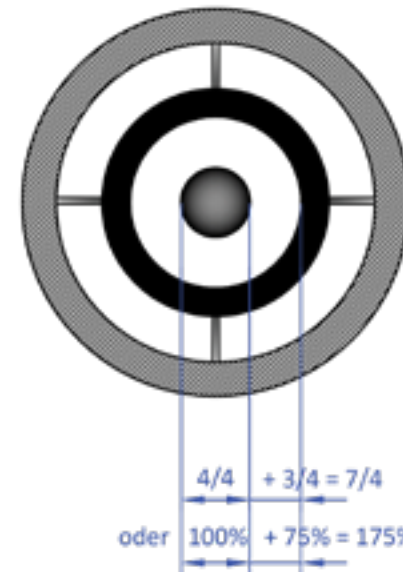

Reinigung Stgw 57
Putzstock Stgw 57



[Art. Nr. 42.3080](#)

ERZINGER Putzstock für Büchsen ab Kaliber 7mm, Holzgriff
 950 mm Länge
Gewinde M5



Carigiet Tipp Nr. 15
Gewehrreinigung



neue Bestmarke mit 576!
 im Zweistellungsmatch mit dem Stgw 90

Adapter Stgw 57

wird benötigt
für Adapter mit
Aussengewinde



[Art. Nr. 42.7003.5](#)

Stil Putzstock-Adapter mit

Innen-Gewinde M5-M5

für Filze



[Art. Nr. 42.1409](#)

Ballistol Filz-Adapter für 3 Filze,
ab Kaliber 7mm

Innen-Gewinde M5

für Patches



[Art. Nr. 42.1393.75](#)

Ballistol Patch-Adapter Alu
Ø 7.5mm

Aussen-Gewinde M5

für Gewehrputzstreifen



[Art. Nr. 42.2632.1](#)

Eyselein Werghalter 7.5mm/.30
Aluminium

Aussen-Gewinde M5

für Paul Clean Patches



[Art. Nr. 42.6222](#)

Patch Adapter GP11/.308 für
Putzstock

Innen-Gewinde M5

Bürsten Stgw 57



normale Verschmutzung

[Art. Nr. 42.3010](#)

ERZINGER Bronzebürste

Innen-Gewinde M5



Patronenlager

[Art. Nr. 42.3011](#)

ERZINGER Bronzebürste
Patronenlager

Innen-Gewinde M5



Konservierung

[Art. Nr. 42.3012](#)

ERZINGER Fettbürste

Innen-Gewinde M5

Patches, Filze & Weiteres Stgw 57

Reinigung / Konservierung



[Art. Nr. 42.1375.30](#) **60 Stk**
[Art. Nr. 42.1376.30](#) **300 Stk.**
 Ballistol **Filzreiniger Klassik**

**Kaliber 7,5 × 55 mm Swiss
(GP11)**

Vorreinigung



[Art. Nr. 42.1380.30](#) **60 Stk**
[Art. Nr. 42.1381.30](#) **300 Stk.**
 Ballistol **Filzreiniger Spezial**

**Kaliber 7,5 × 55 mm Swiss
(GP11)**

Reinigung / Konservierung



[Art. Nr. 42.1390.35](#) **150 Stk**
[Art. Nr. 42.1391.35](#) **500 Stk.**
 Ballistol **Mikrofaser-Patch** rund
 35mm
**Kaliber 7,5 × 55 mm Swiss
(GP11)**

Reinigung / Konservierung



[Art. Nr. 42.3101](#)
 Gewehrputzstreifen Original,
 zu Kal 7.5mm GP11



[Art. Nr. 16.2193](#)
 VNO Stgw57 Putzböckli komplett inkl. Brett

Reinigung / Konservierung



[Art. Nr. 42.6220](#)
 PaulClean Roll Patch
 (Rolle à 250Stk.)

Läufe und Zubehör Stgw 57



[Art. Nr. 70.14.0050](#)/1.712 kg

Stgw57 Lauf mit Abschlussdeckel, Kal. 7.5x55 (GP11)



[Art. Nr. 70.14.0051](#)/15 g

Stgw57 Abschlussdeckel für das Gewinde an der Laufmündung



[Art. Nr. 70.14.0052](#)/1.712 kg

Stgw57 Lauf mit Feuerscheindämpfer, Kal. 7.5x55 (GP11)



[Art. Nr. 70.14.0053](#)/73 g

Stgw57 Feuerscheindämpfer für das Gewinde an der Laufmündung



[Art. Nr. 16.2106](#)/654 g

T11 Variabel Visierteile für Stgw57 (ohne Diopter und Korntunnel)



[Art. Nr. 14.9523](#)/14 g

Korntunnelhülse lang M18 für Stgw57 (T11) mit Stahlringkorneinsatz, Tunnellänge 34 mm

Koffer und Futterale Stgw 57



[Art. Nr. 28.4280](#)

Truttmann Koffer-Futtermal Stgw57, blau gross 2015, für anatomischer Griff + Sportlauf



[Art. Nr. 28.4280.1](#)

Truttmann Koffer-Futtermal Stgw57 schwarz/orange gross 2015, für anatomischer Griff + Sportlauf



[Art. Nr. 28.4099.1](#)

G+E Futtermal schwarz/rot, 136x30x6cm Univeral-Grösse



[Art. Nr. 28.4281](#)

Truttmann Futtermal Stgw57, schwarz/blau mit Rucksackträger, Modell 5716, 123x6x38cm



[Art. Nr. 28.4281.1](#)

Truttmann Futtermal Stgw57, schwarz/rot mit Rucksackträger, Modell 5716, 123x6x38cm

Koffer und Futterale Stgw 90



[Art. Nr. 28.4292](#)

Truttmann Futteral für Stgw 90, schwarz/grau
mit Transportführung für Putzstock, 92x7x30 cm



[Art. Nr. 28.4294](#)

Truttmann Futteral für Stgw 90, schwarz/grün
mit Transportführung für Putzstock, 92x7x30 cm



[Art. Nr. 28.4291](#)

Truttmann Futteral für Stgw 90, schwarz/rot/silber
mit Transportführung für Putzstock, 92x7x30 cm



[Art. Nr. 28.4295](#)

Truttmann Futteral für Stgw 90, schwarz/rot
mit Transportführung für Putzstock, 92x7x30 cm

Koffer und Futterale Stgw 90



[Art. Nr. 28.4293](#)

Truttmann Futteral für Stgw 90, grau/rot
mit Transportführung für Putzstock, 92x7x30 cm



[Art. Nr. 28.3548](#)

Allen Gewehrfutteral Wedge Tac, schwarz oSR
abschliessbar, für PE90 mit offenem Schaft, 104 cm



[Art. Nr. 28.4301.1](#)

Truttmann Tafu gross für Stgw 90 mit Rollen+Henkel schwarz/rot



[Art. Nr. 28.4301](#)

Truttmann Tafu gross für Stgw 90 mit Rollen+Henkel schwarz/blau



STANDORT

Grünig + Elmiger AG
Industriestrasse 22
6102 Malters

KONTAKT

Tel +41 499 90 40
Email info@gruenel.ch

WEBSEITE

www.gruenel.ch

ÖFFNUNGSZEITEN

MO, DI, MI und FR	08.30 - 12.00 Uhr 13.30 - 17.30 Uhr
DO	08.30 - 12.00 Uhr 13.30 - 19.00 Uhr

Immer am 1. Samstag jeden Monat von
08.00 - 12.00 Uhr geöffnet

